

SECONDARY ION MASS SPECTROMETRY **(SIMS)**

CONTENTS

1. Introduction
2. Primary Ion Sources
 - 2.1 Duoplasmatron
 - 2.2 Cs Ion Source
3. The Primary Column
4. Secondary Ion Extraction
5. Secondary Ion Transfer
6. Ion Energy Analyser
7. Mass Analyser
8. Magnetic Field Control
 - 8.1. Hall Probe Detectors
 - 8.2 NMR Detectors
9. Secondary Ion Detectors
 - 9.1 Electron Multipliers
 - 9.2 Faraday Cup
 - 9.3 Image Plate
 - 9.4 RAE Image Detector
10. Electron Charge Neutralisation
11. Vacuum

INTRODUCTION

1.0 Introduction.

Secondary ion mass spectrometry (SIMS) is based on the observation that charged particles (Secondary Ions) are ejected from a sample surface when bombarded by a primary beam of heavy particles.

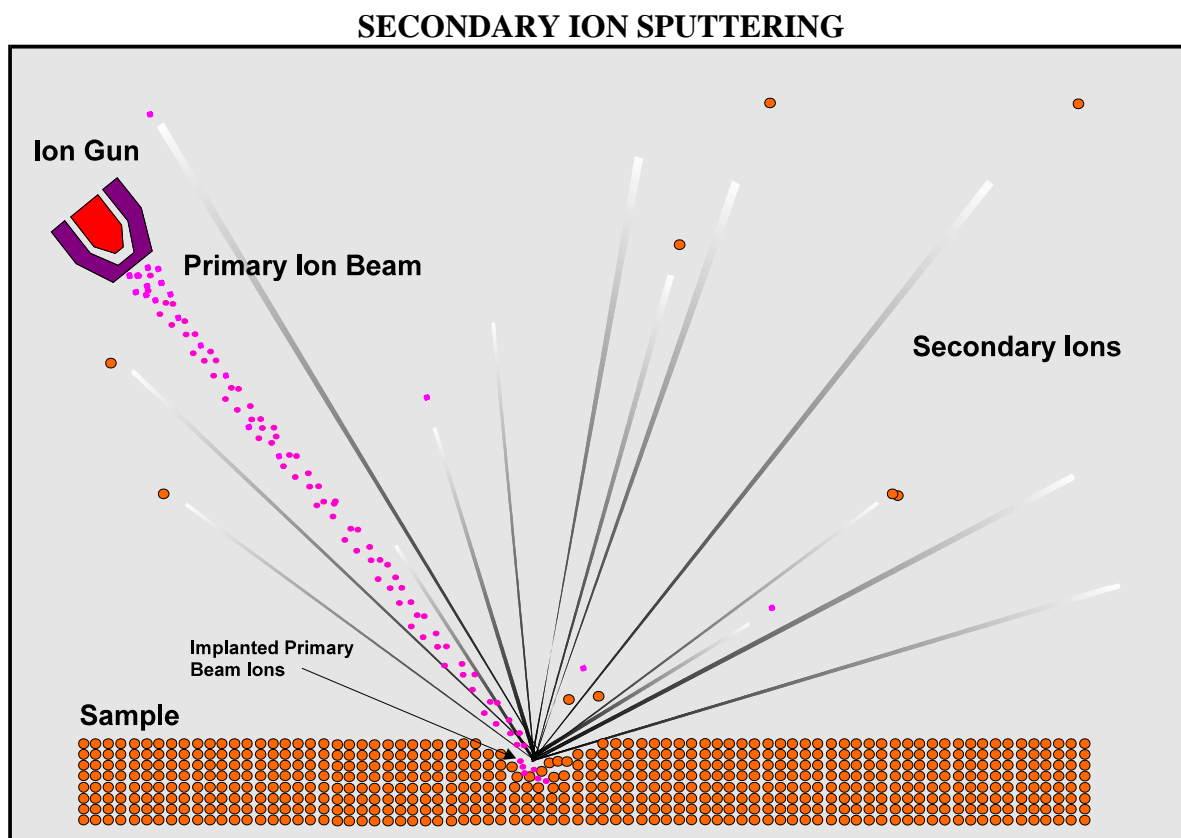

A basic SIMS instrument will, therefore, consist of:

- A primary beam source (usually O_2^+ , O^- , Cs^+ , Ar^+ , Ga^+ or neutrals) to supply the bombarding species.
- A target or sample that must be solid and stable in a vacuum.
- A method of collecting the ejected secondary ions.
- A mass analyser to isolate the ion of interest (quadrupole, magnetic sector, double focusing magnetic sector or time of flight).
- An ion detection system to record the magnitude of the secondary ion signal (photographic plate, Faraday cup, electron multiplier or a CCD camera and image plate).

COMPONENTS OF SIMS

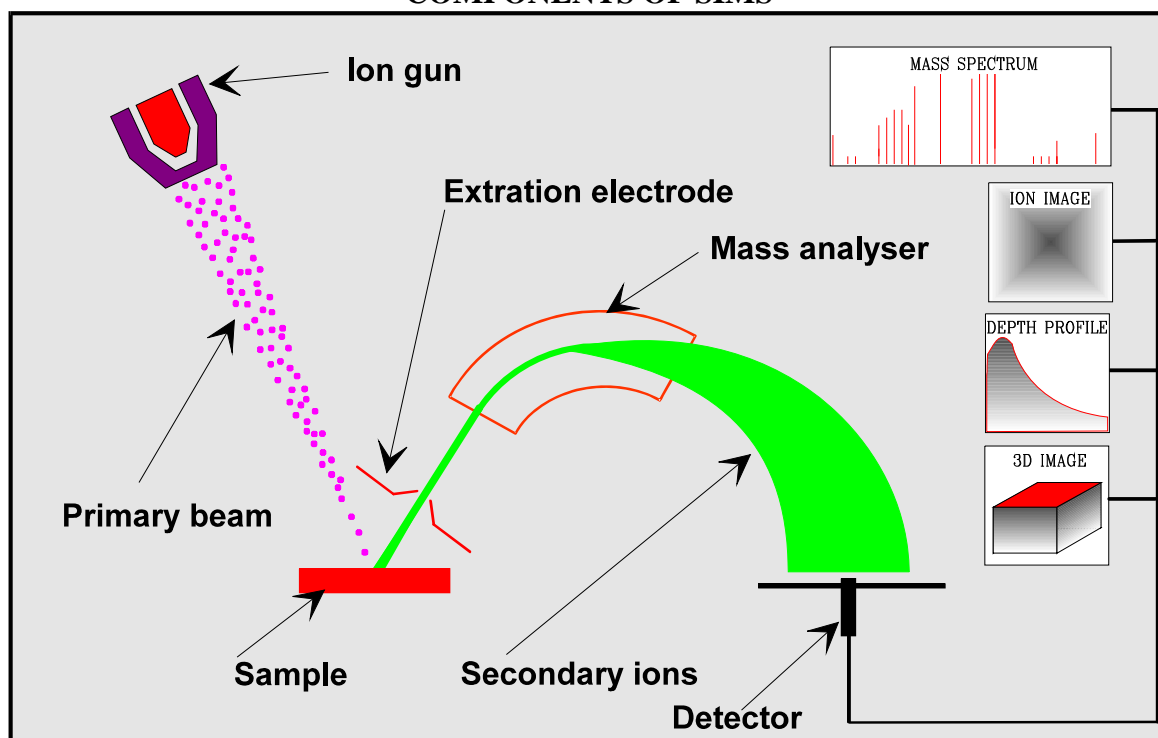

Over the past 50 years SIMS instruments have become some of the most sophisticated of mass spectrometers. The technique offers the following advantages:

- The elements from H to U may be detected.
- Most elements may be detected down to concentrations of 1ppm or 1ppb.
- Isotopic ratios may be measured, normally to a precision of 0.5 to 0.05%.
- Two dimensional ion images may be acquired. A secondary ion leaves the surface at a point close to its original location. This enables localised analysis of the sample to be undertaken and is the cornerstone of ion imaging.
- The volume of material sputtered is small. Using a high-energy and high primary beam densities (dynamic SIMS) a volume of a 100 to 1000 μm^3 is analysed. In contrast, using low-energy and low primary beam densities (static SIMS) the material sputtered is exceedingly small, with surface mono-layers lasting hours or days.
- Three dimensional ion images may be acquired by scanning (rastering) the primary beam and detecting the ion signal as the sample is gradually eroded.
- Little or no sample preparation may be needed.

In contrast, SIMS has some serious limitations:

- The material sputtered from the sample surface consists not only of mono-atomic ions but molecular species that in places can dominate the mass spectrum, making analysis of some elements impossible.
- The sputtering process is poorly understood. No quantitative model currently exists that can accurately predict the secondary ionisation process. In order to obtain quantitative information a suitable standard has to be used and empirical corrections applied.
- The sensitivity of an element is strongly dependent on the composition of the matrix and the type of primary beam used. Standards should, therefore, be close to the composition of the unknown. This is particularly true for isotopic analysis.
- Samples must be compatible with an ultra high vacuum.

The following text describes the basic components of a modern SIMS instrument, with particular emphasis on the Cameca ion microprobes and their use in the Earth Sciences. The document: More On SIMS, describes the details of each instrumental component in more detail, while the final document: SIMS Analysis, describes the basic analytical assumptions and procedures used at the NERC Ion Microprobe Facility for the analysis of Earth Science Materials.

CAMECA IMS-4F

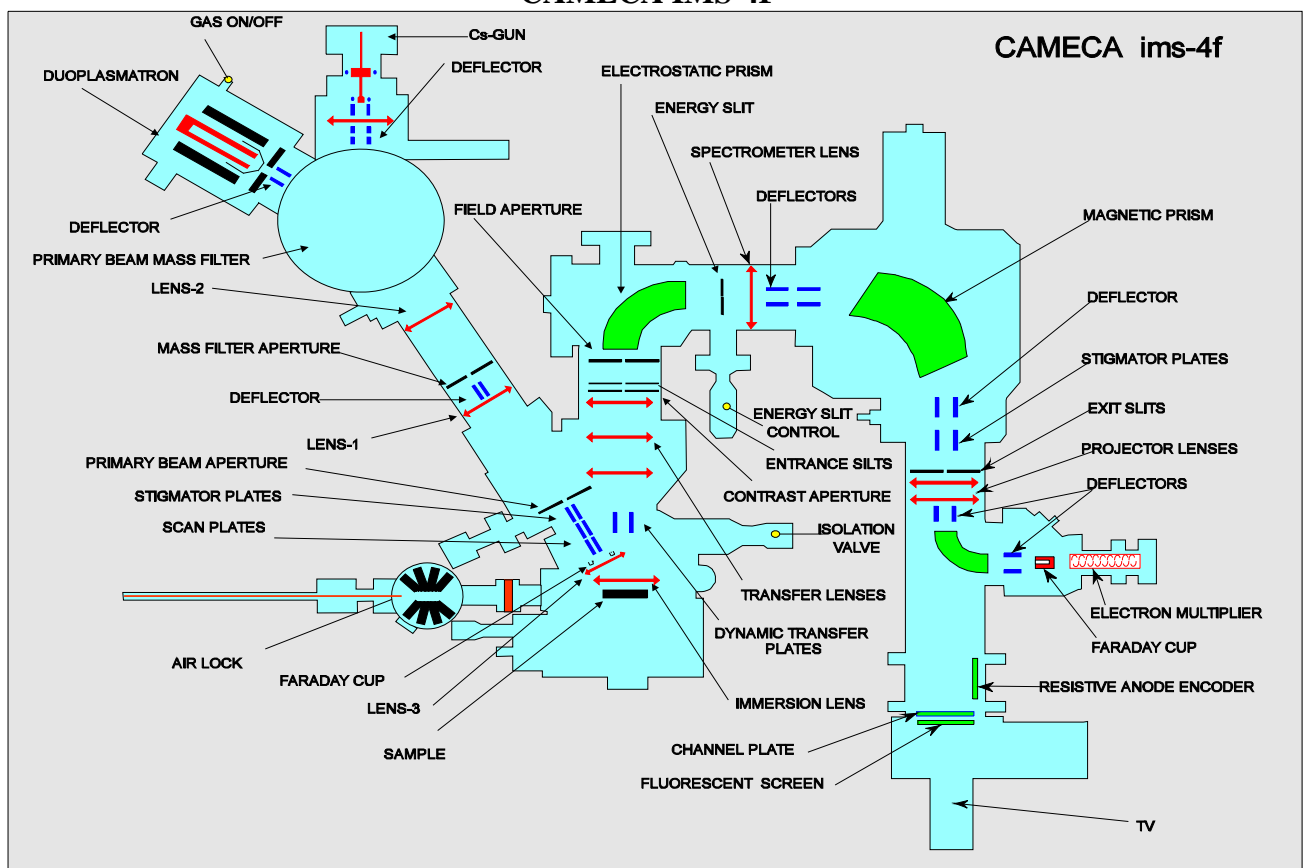

CAMECA IMS-1270

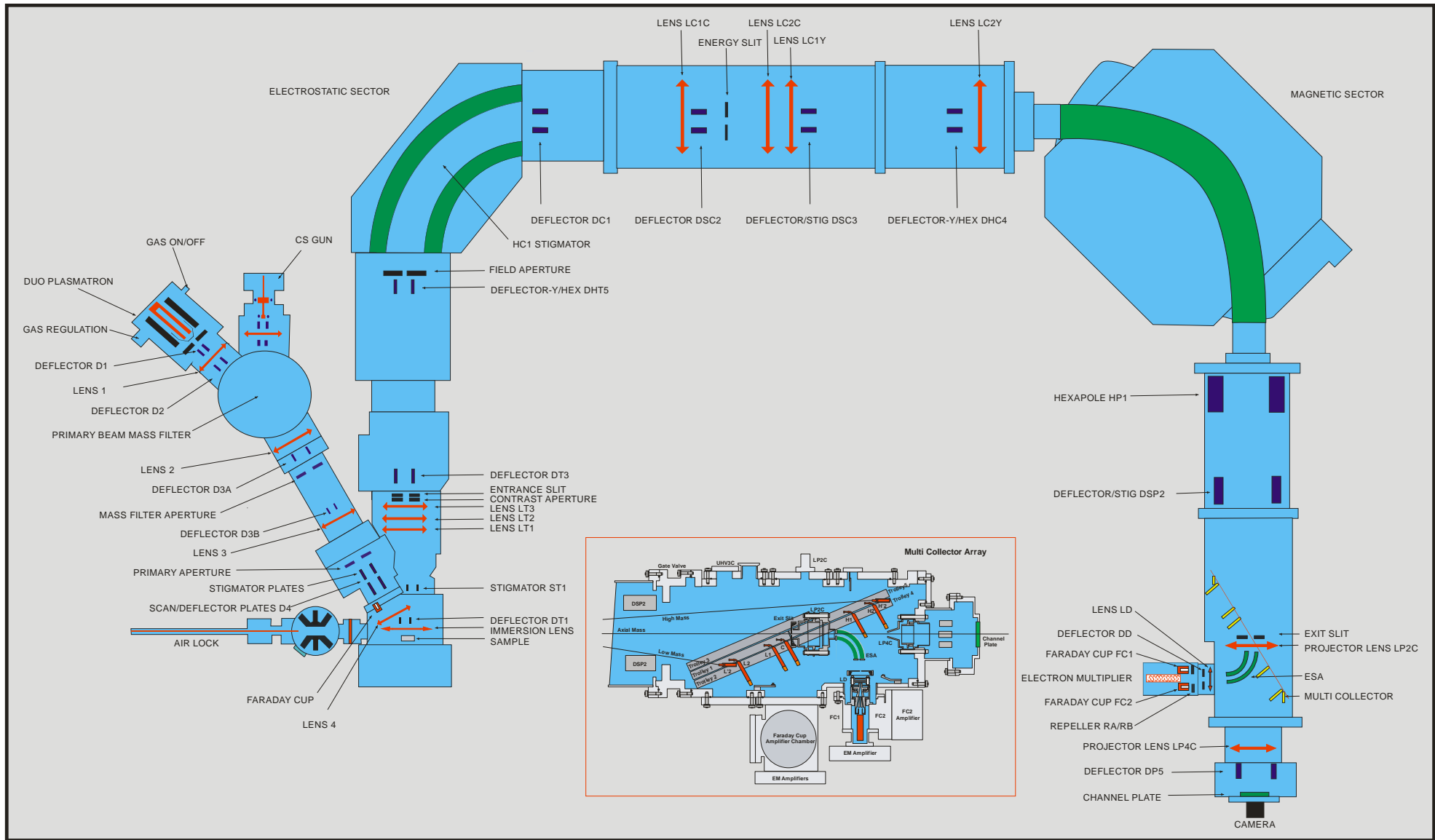

PRIMARY ION SOURCES

2. Primary Ion Sources.

Modern SIMS instruments are equipped with a duoplasmatron, a Cs ion source, or a Ga ion source. The NERC Scientific Services ims-4f (No. 130), and the ims-1270 (No. 8) installed at Edinburgh University have both a duoplasmatron and a Cs-source.

2.1 Duoplasmatron.

The duoplasmatron can operate with almost any gas including air. Oxygen is commonly used because it enhances the yield of electropositive elements such as Al, Si, REE etc. The duoplasmatron may be used to extract either O^- or O_2^+ depending upon the electrical polarity selected by the operator. In negative mode O^- is the most abundant species, while in positive mode O_2^+ is most abundant. When insulating samples are analysed, O^- has the advantage of preventing charge build-up on the sample surface.

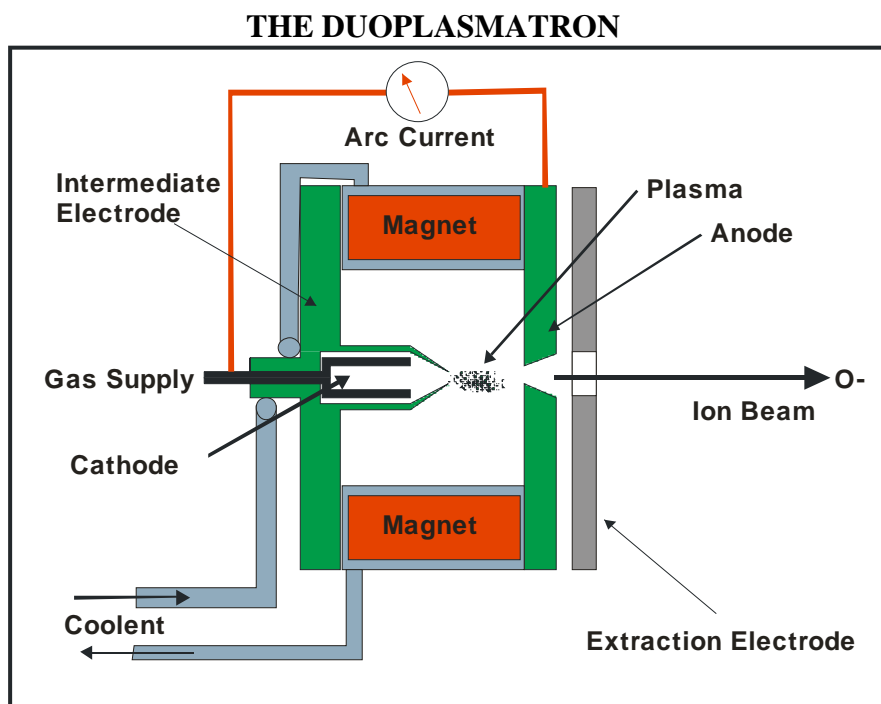

Many ion species are generated within the duoplasmatron and it is left to the primary beam mass filter to select the desired ion beam (Section 3).

2.2 Cs Ion Source.

Cs ion beams are used to enhance the yield of electronegative elements such as C, O, and S etc. within the target. The Cs gun can only operate in positive mode. In general Cs beams are smaller than those generated by the duoplasmatron, and sputter material more effectively because of their greater mass. However, the Cs gun is expensive to operate and is only routinely used for oxygen, sulphur or carbon isotopic analysis. When insulators are analysed some method of neutralising the positive charge build-up, created by the Cs^+ beam, is required (section 9).

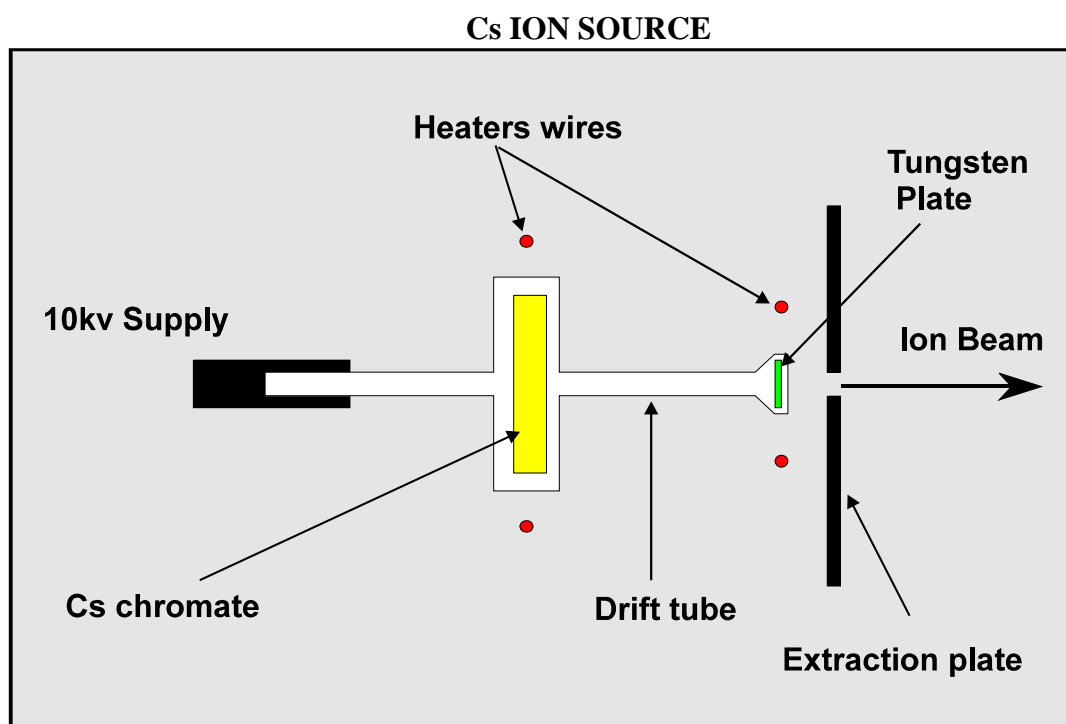

In the Cameca ims-series, Cs ion beams are generated by a surface ionisation process. Cs vapour is produced by the heating of a solid Cs compound (Cs-chromate or Cs-carbonate). The Cs vapour travels along the drift tube and strikes a tungsten plate where it is thermally ionised. Any atom or molecule coming from the reservoir is forced to bounce between the tungsten plate and the ioniser tip. This results in most atoms being ionised and escaping through the small hole in the cap.

PRIMARY ION COLUMN

3. The Primary Column.

The primary ions generated by the ion source are passed to the sample via the primary column.

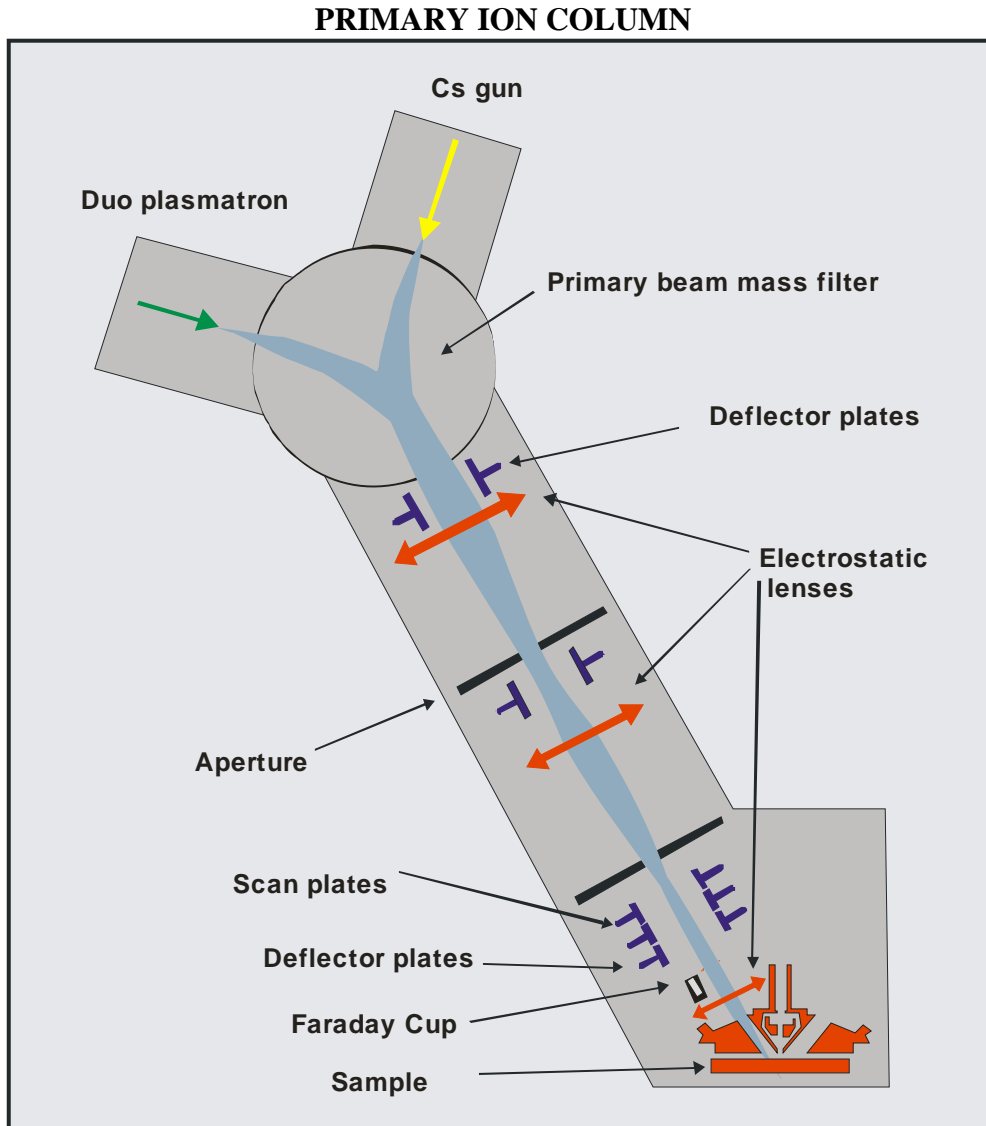

A typical column consists of a mass filter, apertures, lenses and deflection plates. Their function is to filter, focus, shape, position and raster the primary beam. The primary beam mass filter eliminates any impurities in the gas or generated in the ion source. In the case of the duoplasmatron the filter removes OH, N, Fe and Ni. Without the mass filter these and other components would be implanted into the sample surface, increasing their detection limit. With the mass filter only oxygen ions are allowed to bombard the sample.

The electrostatic lenses and apertures control the intensity and shape of the primary beam. Several sizes of aperture are available and are selected depending on the beam size required. Their

position may be adjusted so that the primary beam passes through the centre of the electrostatic lens.

The deflectors either steer the primary beam through the centre of the lenses, shape the beam, position the beam, or raster the beam at a high frequency (thus producing an even beam density over a large area).

In the Cameca ims-4f, the duoplasmatron beam passes through three or four lenses and five sets of deflector plates.

SECONDARY ION EXTRACTION

4. Secondary Ion Extraction.

Secondary ions are formed at the sample surface by the bombardment of the primary beam. These secondary ions are immediately removed by an extraction, or immersion lens. In the Cameca system the sample is held at a high potential (± 4500 or $\pm 10,000\text{V}$) and the first member of the extraction lens is at ground potential.

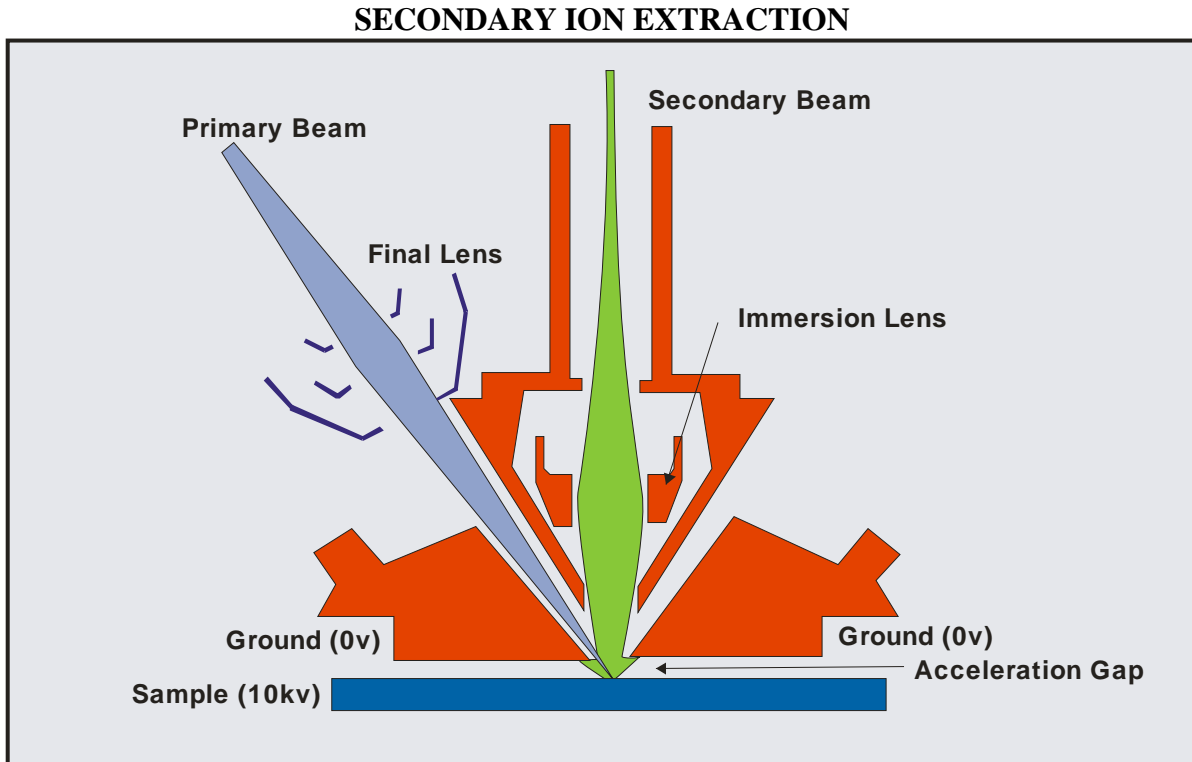

Depending upon the polarity of the sample, positive or negative secondary ions may be extracted. The polarity of the secondary ions is user selected and is independent of the primary beam polarity.

In order to obtain a constant secondary ion beam current, the potential difference between the sample and the extraction (immersion) lens, must be kept constant. With an insulating sample this is partially achieved by coating the surface with a thin layer ($<0.02\ \mu\text{m}$) of gold or carbon. Under these conditions only minor voltage changes occur, and any charge build-up may leak away via the gold coat to ground.

SECONDARY ION TRANSFER

5. Secondary Ion Transfer.

After the secondary ions have been extracted from the sample surface by the immersion lens they are transferred by a second electrostatic (transfer) lens into the mass spectrometer. The purpose of this transfer lens is to form a real magnified image of the sample surface at the position of the field aperture and to focus the secondary ion beam onto the entrance slit of the spectrometer.

At the same position as the entrance slit is the contrast aperture. Smaller contrast apertures intercept ions with off-axis components, resulting in greater spatial resolution but reduced ion intensities.

The immersion lens and the transfer lens together form the Cameca ion microscope, which enables an image to be viewed by an appropriate detector at the position of the field aperture. The Cameca has three transfer lenses, but only a single lens is used at any one time, and is user selected. Each lens produces a different magnification of the sample surface at the position of the field aperture.

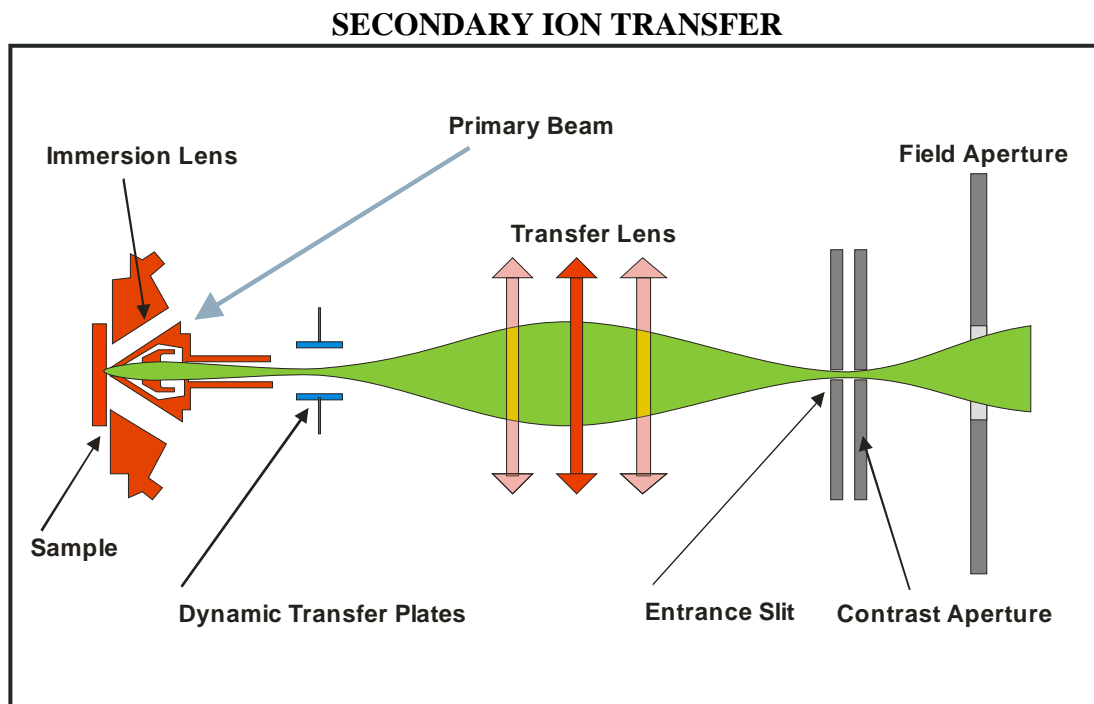

When the primary beam raster is large, the secondary ion beam can, at times, be off axis. This results in aberrations at the entrance slit of the spectrometer and prevents clean separation of different masses. This is corrected using the dynamic transfer plates. These deflect all the secondary ions formed during the raster, back on axis so they pass through the centre of the transfer lens. However, the direct imaging capability in microscope mode is lost, but high mass resolution may be achieved for any raster size.

ION ENERGY ANALYSER

6. Ion Energy Analyser.

Secondary ions generated during the sputtering process have a wide range of energies. As these secondary ions pass into the electrostatic energy analyser, the lower energy ions are more strongly deflected than the high energy ions. A movable energy slit placed after the energy analyser can select a small portion of the dispersed secondary ions and allow them to pass into the magnetic analyser.

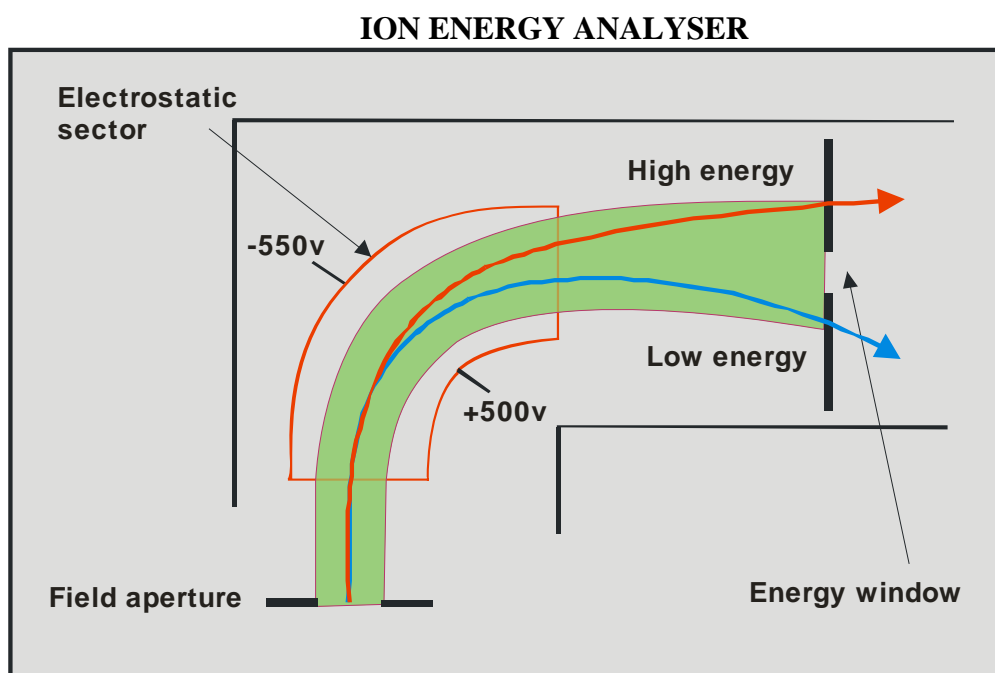

The inner and outer spherical electrode surfaces of the energy analyser have voltages of opposite polarity; which is positive and which negative depends on the polarity of the secondary ion beam.

As a consequence of the sputtering process, molecular species are abundant at low energies, while the mono-atomic species dominate the higher energy spectrum. By moving the energy window so that only the higher energy ions are accepted, the molecular and often unwanted species can be suppressed. An identical result may be achieved by lowering the sample voltage and keeping the energy window centred.

An electrostatic spectrometer lens is placed between the energy analyser and the magnetic analyser. It is an electrostatic lens that aligns the energy filtered ion beam into the magnetic analyser.

MASS ANALYSER

7. Mass Analyser.

As an ion beam passes through a magnetic field, the ions are acted on by a force at right angles to both the direction of motion of the ion and to the direction of the magnetic field. In the Cameca mass analyser, the magnetic field is vertical. The magnitude of the magnetic field required to deflect the ion species is given by the equation:

$$\frac{m}{q} = \frac{B^2}{2V} \times r^2$$

m/q	=	Mass to charge ratio (Kg and C).
B	=	Strength of the magnetic field (Wb/m ²).
V	=	The ion accelerating voltage (V).
r	=	The radius of curvature of the magnetic field (m).

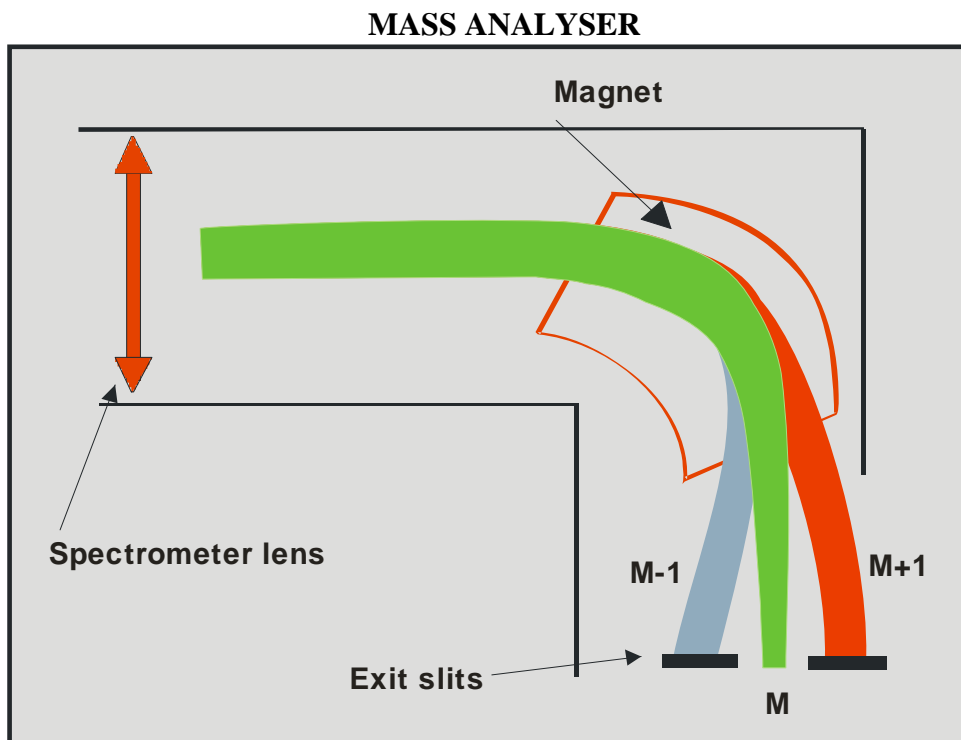

The strength of the magnetic field is measured by a semiconductor device; the Hall probe. This is located in the magnetic flux and is used to control the current flowing in the coils of the electromagnet.

A magnetic analyser cannot effectively separate ions that have a wide range of energies. However, in combination with the energy analyser, aberrations are reduced and the instrument is said to be double focusing, and can attain high mass resolution.

MAGNETIC FIELD CONTROL

8. Control of the Magnetic Field

It is critical to accurately control the magnetic field so that a stable secondary ion signal is received at the ion detectors over long periods of time.

The field may be controlled by either electronic circuits that provide a constant current flowing through the magnetic field coils (as in the Primary Beam Mass Filter) or by incorporating a measuring device in the magnetic field that provides feedback information to the electronics to provide better regulation. Two feedback devices may be considered: The Hall Probe and The NMR.

8.1 Hall Probe:

When an electric current flows through a conductor in a magnetic field, the magnetic field exerts a force on the moving electrons that tends to push them to one side of the conductor. This build up of charge produces a voltage between the two sides that can be measured and used to feedback to the electronics that control the magnetic field. The presence of this transverse voltage is called the Hall Effect after E. H. Hall who discovered it in 1879.

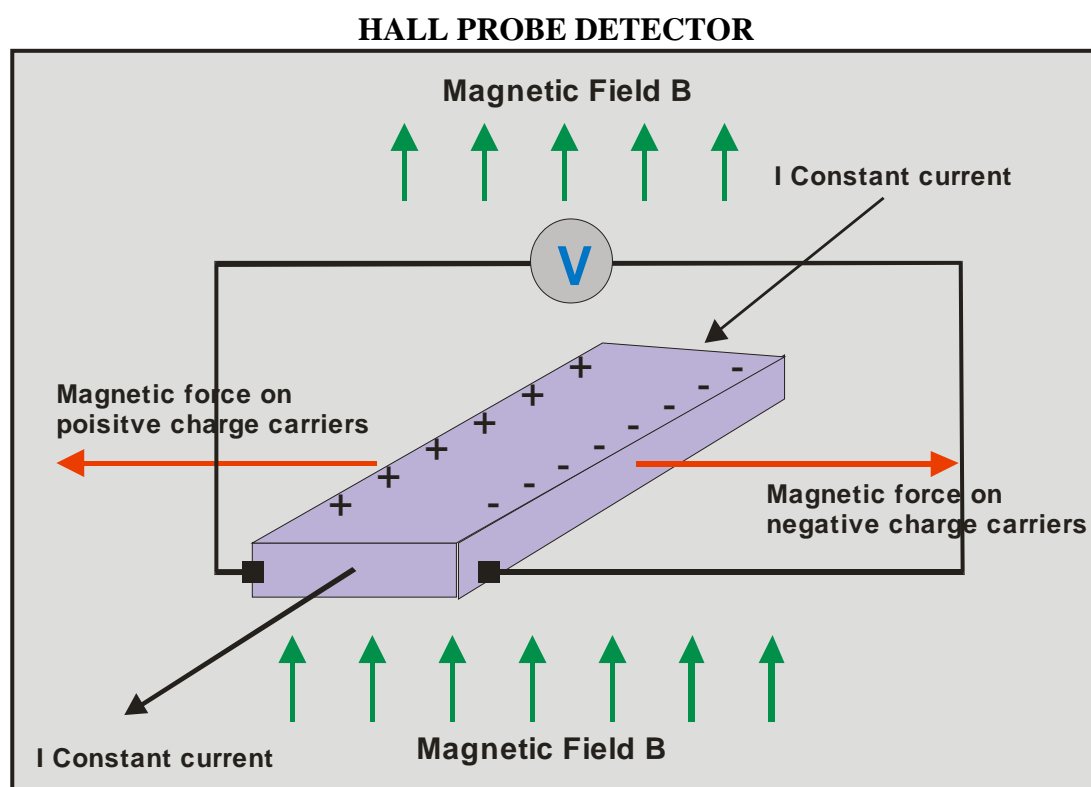

The major disadvantage of the Hall probe is that it is very sensitive to changes in the ambient temperature conditions.

8.2 Nuclear Magnetic Resonance Probe (NMR).

The theoretical basis for Nuclear Magnetic Resonance was proposed by W. Pauli in 1924 who suggested that certain atomic nuclei should have properties of spin and magnetic moments. It was not until 1946 however that Stanford and Purcell demonstrated the theory that some nuclei absorb radio frequency electromagnetic radiation when they are placed inside a strong magnetic field. In 1952 both Stanford and Purcell received the 1956 Nobel Prize for their work. It is the absorption and consequent relaxation of the nuclei to the radio frequency that forms the basis of the NMR probe.

To account for the properties of some nuclei, it is necessary to consider that they rotate about an axis. The nuclei have a charge and, as it is spinning, it gives rise to a magnetic field. In the absence of an external magnetic field there is equilibrium between the magnetic quantum states of the nuclei. When the nucleus is brought into a magnetic field it will become orientated in the lower energy state. If the sample is then subject to an additional radio frequency electromagnetic signal, each little nuclear magnet absorbs energy and flips into another energy state. The frequency of the applied signal needed to do this depends on the strength of the external field. It can be demonstrated that the number of low energy versus high energy state of the nuclei is linearly related to the magnetic field strength. So, by switching off the radio frequency, the system reverts back to their original orientation emitting an electromagnetic radio frequency that can be measured and is dependant on the external magnetic field.

NMR PROBE

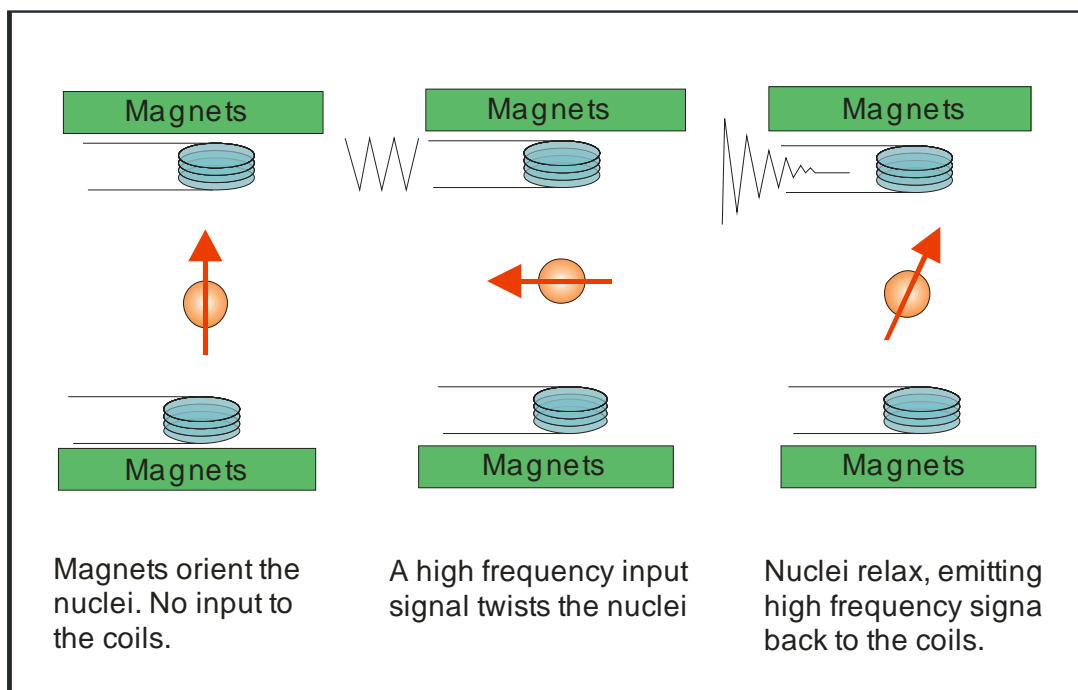

SECONDARY ION DETECTORS

9. Secondary Ion Detectors.

Most modern mass spectrometers have more than one detector. The Cameca ims-4f has four secondary ion detectors; an electron multiplier, a Faraday cup, an image plate and a resistive anode encoder. In this instrument, only one detector can be used at any time. In the Cameca ims-1270 the instrument is equipped with eleven detectors some of which can be used simultaneously to give higher precision and rapid acquisition.

9.1 Electron Multiplier.

The electron multiplier is the most sensitive detector. If protected from stray ions, neutrals and cosmic rays, then the background count rate is normally less than 0.01 counts per second (c/s). However, the multiplier must also be protected from intense ion beams ($>5 \times 10^6$ c/s) as these can rapidly lead to its destruction.

An electron multiplier consists of a series of electrodes called dynodes. Each dynode is connected to a resistor chain. The first dynode is at ground potential, so that both positive or negative ions may be detected. The last dynode can be between +1500 to +3500 V depending on the age and type of multiplier. When a particle (electron, neutral, ion etc.) strikes the first dynode it *may* produce a few (1, 2 or 3) secondary electrons. These secondary electrons are accelerated to the second dynode that is held at a slightly higher positive potential. On impact more secondary electrons are generated and a cascade of secondary electrons ensues.

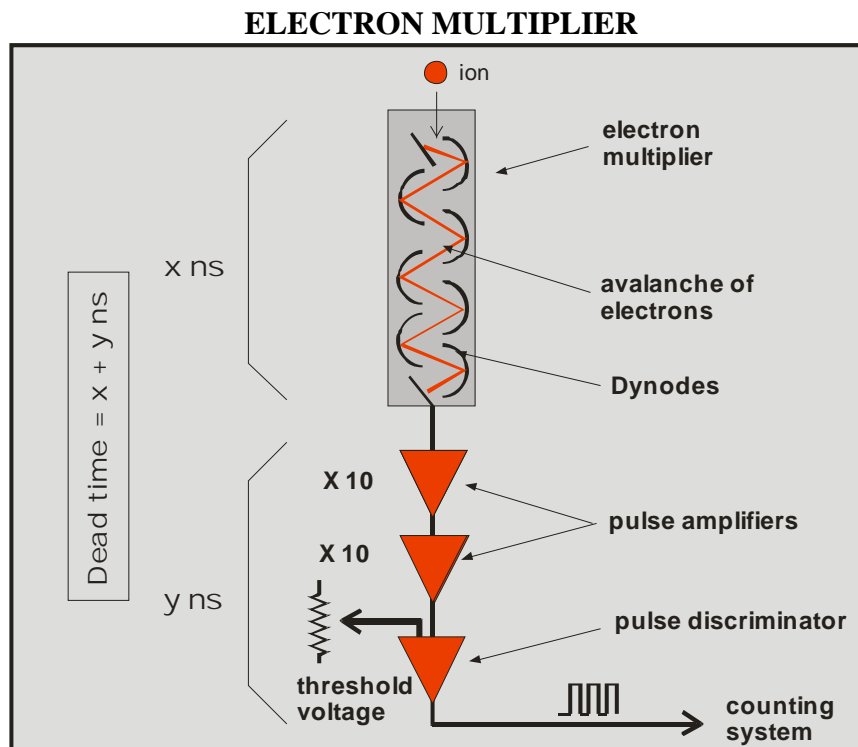

The type, composition (Cu/Be, Al₂O₃, Ni, Ag etc.) and number of dynodes, the accelerating voltage between dynodes, the impact energy and type of the charged particle, all govern the magnitude of the pulse recorded at the end of the dynode chain. As the multiplier gets older, the efficiency of secondary electron production is reduced, mainly due to carbon contamination on the dynode surfaces. The dynodes may be regenerated but a multiplier replacement is often more cost effective.

For optimum performance, the electron multiplier should operate at sufficiently high voltage so that every ion arrival produces a pulse. This pulse is then amplified and as long as it is above a set threshold, it will be passed to the counting circuit. The time taken for the multiplier, amplifier and discriminator, to process a pulse is known as the dead time (τ). With fast pulse-processing circuitry, this is in the order of 15 to 20 ns and limits the electron multipliers maximum count rate to about 5×10^6 c/s if the dead time correction is to be kept low. At a count rate of 5×10^5 c/s and a dead time of 25 ns the percentage correction is about 1.3%. The true count rate (\mathbf{n}) may be calculated from the observed count rate (\mathbf{n}_0) by the equation:

$$\mathbf{n} = \frac{\mathbf{n}_0}{1 - \mathbf{n}_0 \tau}$$

Pulse counting detectors follow Poisson statistics which require that each ion arrives independently of all other ions. If, in a fixed interval of time, \mathbf{n} counts are detected, the standard deviation of the measurement is given by:

$$SD = \sqrt{\mathbf{n}}$$

and the relative standard deviation is given by:

$$RSD = \frac{\sqrt{\mathbf{n}}}{\mathbf{n}} = \frac{1}{\sqrt{\mathbf{n}}}$$

9.2 Faraday Cups.

A Faraday cup detector can detect count rates from 5×10^4 c/s upwards. Unlike the electron multiplier it does not discriminate between the type of ion or its energy. It is simple and cheap, but its response time is slow.

The Faraday cup detector consists of a hollow conducting electrode connected to ground via a high resistance. The ions hitting the collector cause a flow of electrons from ground through the resistor. The resulting potential drop across the resistor is amplified. A plate held at about -80 V in front of

the collector, prevents any ejected secondary electrons from escaping and causing an anomalous reading.

FARADAY CUP

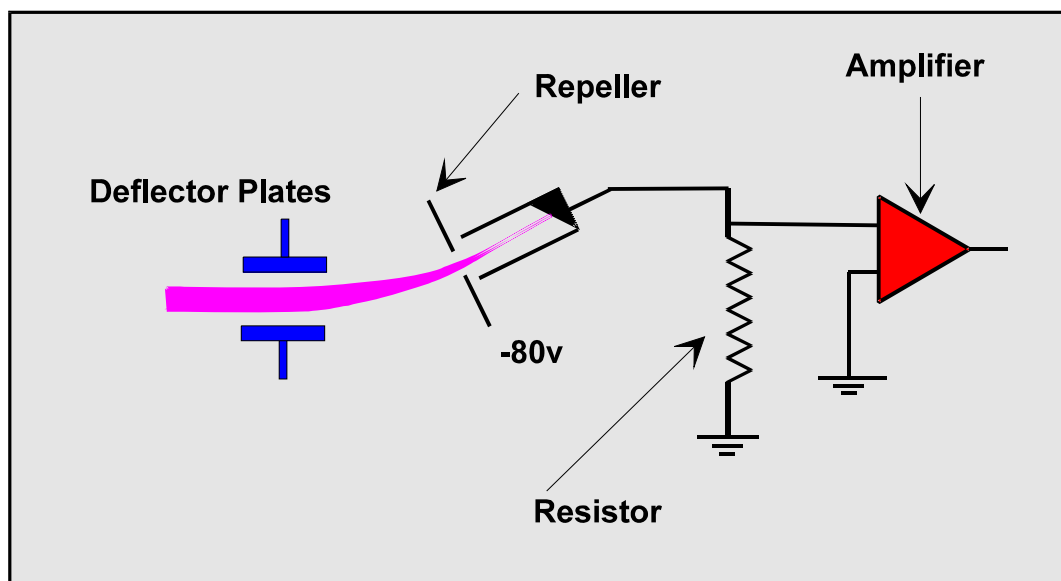

A single charge on a single ion is 1.6×10^{-19} C. Therefore a count rate of 1×10^6 c/s would produce a current of 1.6×10^{-13} Amps. With a resistor of $10 \text{ M}\Omega$ connected to ground, the amplifier must be able to detect a potential drop of 1.6×10^{-6} (0.0016 mV). The detection limit of the Faraday cup is limited by the thermal noise in the resistor and the quality of the amplifier. Often these components will be enclosed within an evacuated, thermally controlled chamber.

9.3 Image Plates.

An ion image plate consists of an array of miniature electron multipliers composed of lead glass. Typically the electron multipliers, or channels, are about $10 \mu\text{m}$ in diameter, $400 \mu\text{m}$ long and about 7° from the perpendicular to the plate face. They are located about $12 \mu\text{m}$ between centres and number up to 2000 in a 25 mm array. The front face of the plate is held at ground potential, while the back plate may be between +1000 to +2000 V.

An ion passing down a channel hits the inner channel wall and produces secondary electrons. The channels are designed so that these secondary electrons initiate an electron cascade down the channel. The pulse of electrons from the back of the detector may either be passed to a second micro channel plate for further gain, or accelerated towards a phosphor screen, where their impact may be viewed directly.

MICRO-CHANNEL PLATE

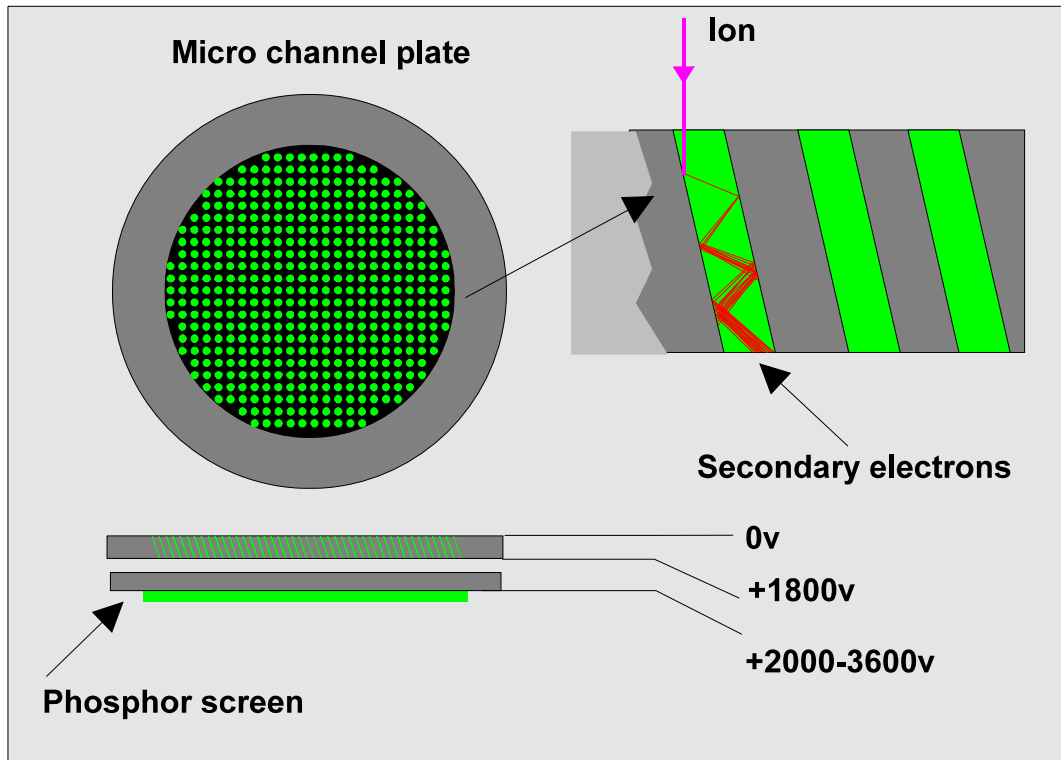

As with the discrete dynode electron multipliers, these micro-channel plates do discriminate according to the ion species, and over a period of time, the secondary electron gain is reduced. Under ideal operating conditions, a count rate of ~ 5000 c/s should be visible on the phosphor screen.

9.4 RAE Image Detectors.

The resistive anode encoder is a position-sensitive detector. It is used to digitally record ion images. The background count rate is high, but constant over a period of time, and the maximum count rates must be less than 4×10^4 c/s. Because it uses a micro-channel plate for the ion to electron conversion, the detector discriminates between species.

An ion enters a channel in the first of two micro-channel plates. The ion to electron conversion results in a pulse of electrons that emerge from the back of the first plate to initiate a second electron cascade in the channels of a second plate. The resulting electron pulse strikes a resistive plate comprising a thick resistive film, deposited on a ceramic plate. The geometry of the detector is designed to avoid image distortion. The charge pulse is partitioned off to four electrodes at the corners of the plate.

RESISTIVE ANODE ENCODER

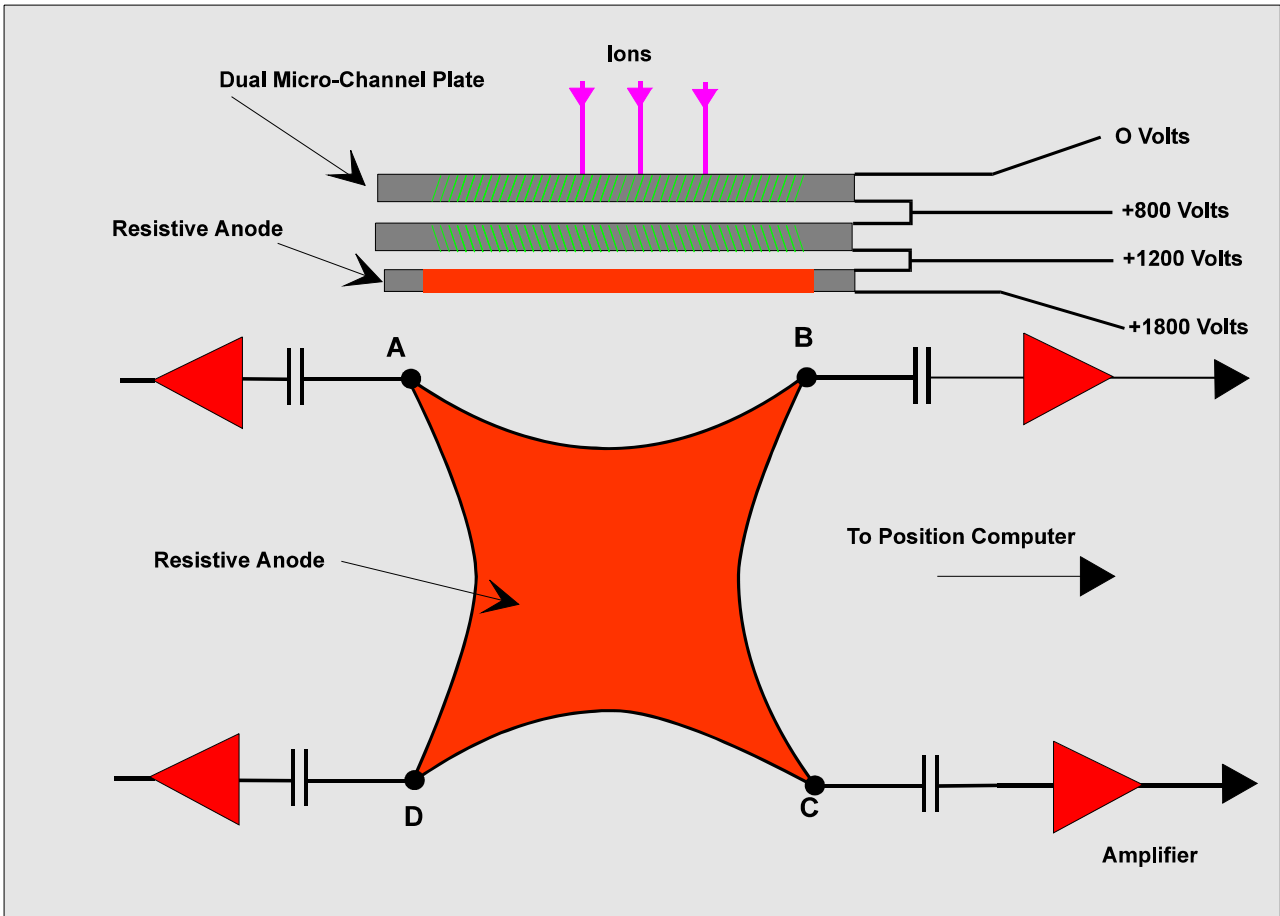

The pulses are amplified and passed to the position computer where the X and Y position is calculated by the equations:

$$X = I_B + I_C / I_A + I_B + I_C + I_D$$

$$Y = I_A + I_B / I_A + I_B + I_C + I_D$$

The calculation of the electron impact position can take a long time (2-3 μ s), resulting in an overall dead time of 4.3 μ s.

ELECTRON CHARGE NEUTRALISATION

10. Electron Gun.

Irrespective of the polarity of the primary or secondary beam, some charge build-up occurs on the surface of insulating specimens. In many cases the build-up is small, and can be ignored. In other cases, some method of charge neutralising is essential. In the case of a positive primary beam and negative secondary ions, the number of negative particles extracted is much greater than one and the sample charges positively. Under these conditions the sample must be simultaneously bombarded with additional high- or low-energy electrons if charge build-up is to be reduced.

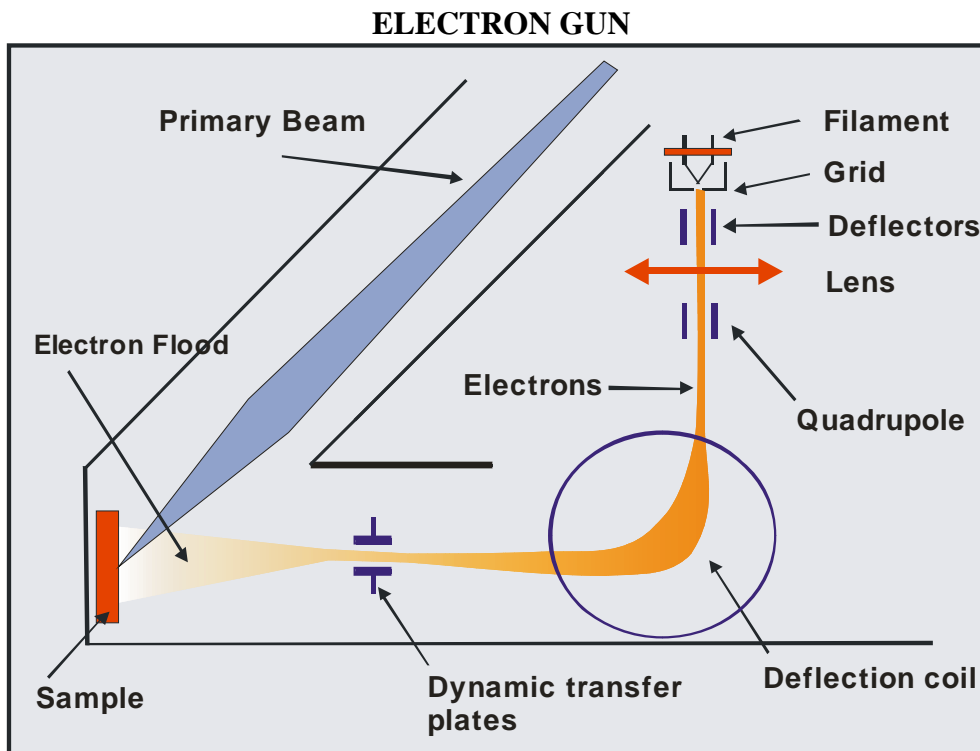

The Cameca instruments use a low-energy electron flood gun. A tungsten filament is held between -4500 and $-10,000$ V depending on the sample voltage. The electrons emitted from the filament pass through deflectors and a quadrupole lens that is used to shape and focus the electron beam. A magnetic prism (deflection coil) deflects the electrons by an angle of 90° towards the sample. After passing through the immersion lens the electrons arrive at the sample surface (also held at -4500 or $-10,100$ V) with zero energy. Therefore when negative secondary ions are analysed, a cloud of low energy electrons are formed just above the sample surface where they are available for charge compensation. When positive ions are analysed the sample is held at $+4500$ or $10,000$ V and the electrons strike the sample at a voltage and current adjusted to give a stable signal.

VACUUM

11. What is Vacuum?

An essential requirement for the operation and analysis is that the instrument is kept under Ultra High Vacuum (UHV). The vacuum is achieved and maintained by a variety of pumps: Rotary, Turbo molecular, Ti-sublimation and Ion pumps. The condition of the vacuum system is continuously monitored by an equal variety of vacuum gauges: Thermocouple, Penning, Cold cathode and Bayard-Alpert gauges. The level of vacuum required is one of the highest of all analytical instruments and requires extreme care with sample preparation and maintenance.

The vacuum in the analysis chamber can get down to 5×10^{-10} Torr. This is equivalent to approximately 10^{10} molecules/Litre while air has 2.7×10^{22} molecules/Litre. Under these vacuum conditions the probability of a secondary ion hitting a gas molecule within the instrument is almost zero.

VACUUM Vs ALTITUDE

